

## CNC Vision Measuring System QUICK VISION Active Series

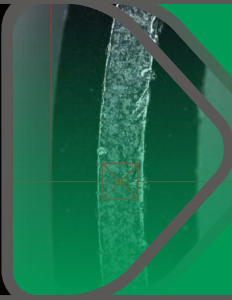

Easy-to-operate, space-saving model with advanced functionality to meet various needs

# QUICK VISION Active



High Efficiency



Flexible Utility

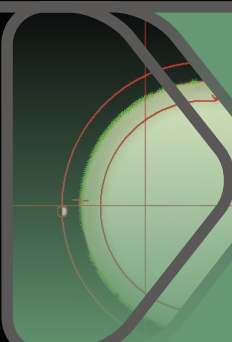

Simple but Advanced Platform



# High Efficiency

**Constant attendance is not required.**  
**The operator can engage in other tasks.**

## Controlling the variation of measurement data

### Automatic edge detection

The "automatic edge detection" function will provide high reproducibility in measurements regardless of the skill level of the operator.

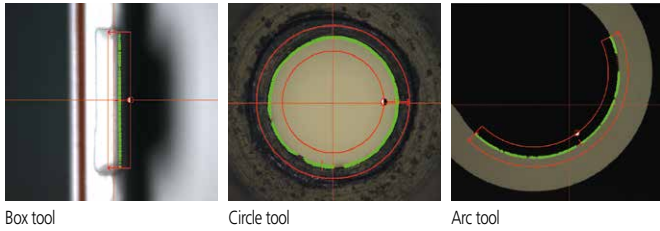

### Image auto focus

Appropriately setting up the "image auto focus" function will enable reliable and high-speed height measurements.

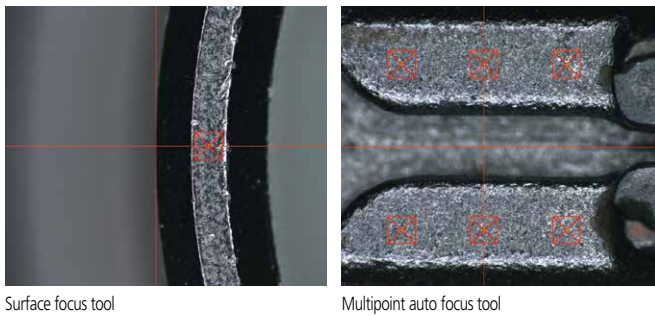

## Continuous measurement of multiple workpieces

### Step & repeat

The "step&repeat" function will measure a large number of workpieces on the positioning jig in one operation.

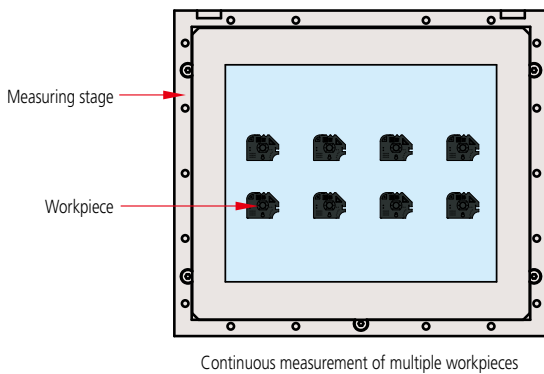

## Automatic measurement can be started just with rough positioning

### Pattern search

The "pattern search" function automatically recognizes the registered form of the workpiece.

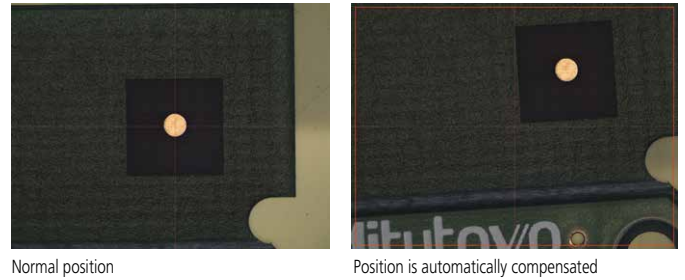

### Manual tool

By incorporating "manual tool" measurement into automatic measurement, it is possible to perform measurement with temporary positioning, enabling automatic measurement to be started with the workpiece placed at any position on the stage. Making a positioning jig is not required, which results in cost and man-hour reduction.

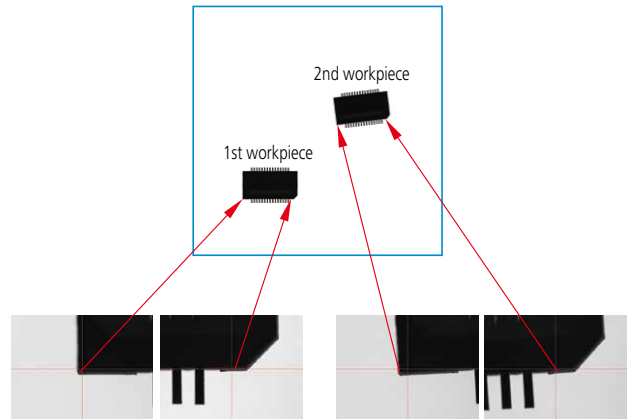

## No changeover is required in the continuous measurement of three-dimensional objects

### Touch-probe equipped models

With the Vision Measuring System, the side face of a three-dimensional object, or the height of metal/resin moldings can be measured using a touch-probe.

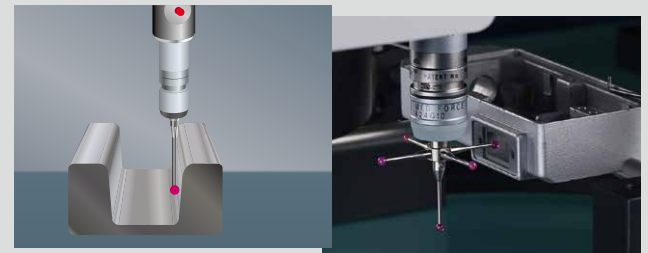

# Flexible Utility

## From wide view measurement to micro-measurement

### Interchangeable objective lens zoom unit

The newly designed zoom unit and interchangeable objectives achieve a maximum magnification ratio of 14X. Viewing possibilities extend from low magnification wide view measurement to high magnification micro-measurement.

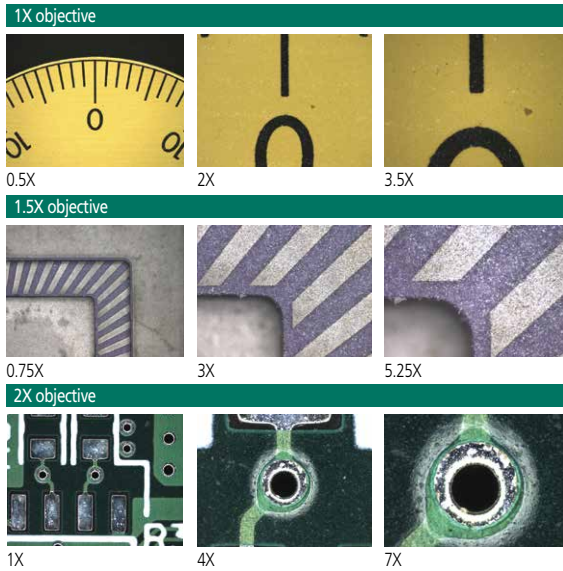

1X objective (optional)      1.5X objective (Standard accessory)      2X objective (optional)

Optical magnification	0.5X	0.65X	0.75X	0.85X	0.98X	1X	1.28X	1.3X	1.5X	1.7X	2X	2.25X	2.5X	3X	3.5X	3.75X	4X	5X	5.25X	7X	
View field (mm)	Horizontal (H)	13.60	10.46	9.07	8.00	6.94	6.80	5.31	5.23	4.53	4.00	3.40	3.02	2.72	2.27	1.94	1.81	1.70	1.36	1.30	0.97
	Vertical (V)	10.80	8.31	7.20	6.35	5.51	5.40	4.22	4.15	3.60	3.18	2.70	2.40	2.16	1.80	1.54	1.44	1.35	1.08	1.03	0.77
Total magnification (on the monitor)	13.20	17.10	19.80	22.40	25.80	26.40	33.70	34.30	39.50	44.80	52.70	59.30	65.90	79.10	92.30	98.90	105.50	131.80	138.40	184.50	
Objective lens	1X objective Working distance	74 mm																			
	1.5X objective Working distance	42 mm																			
	2X objective Working distance	42 mm																			

Note: The total magnification indicates the magnification on the monitor when the size of the QVPAK video window is 178.8x143.0 mm (default).

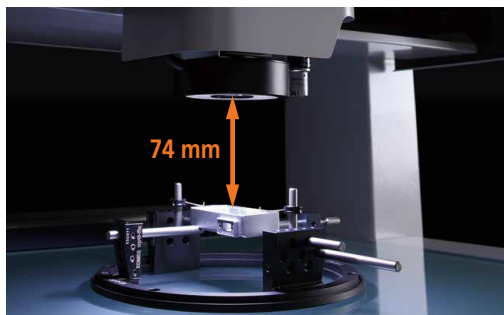

## Large stepped features can be measured safely

### Large working distance

A working distance of 74 mm\* practically eliminates the risk of damaging the objective or workpiece by accidental collision.

\* Using the 1X objective.

## Vision/touch-probe combination measurement

The QV Active Series can perform complicated measurements that are usually made using tools such as calipers, dial indicators, or measuring microscopes. This will make a great contribution to reducing the number of measurement processes and optimizing the use of production resources.

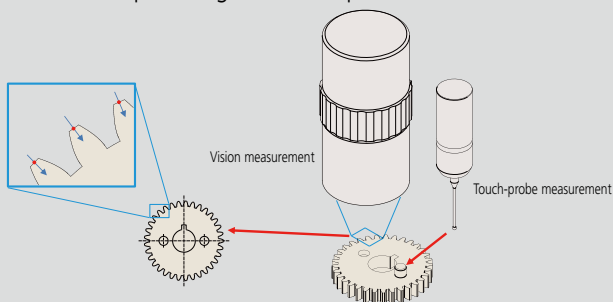

## Module change rack, MCR20

A maximum of three touch-probe modules can be mounted in this rack to meet a variety of needs, with the probe auto-change function complementing the QV Active imaging functionality.



**Master ball** (optional)  
Used for diameter compensation of the stylus.

**Calibration ring** (optional)  
Used for offset calibration of the image and the touch probe.



**MCR20** (optional)



# Simple but Advanced Platform

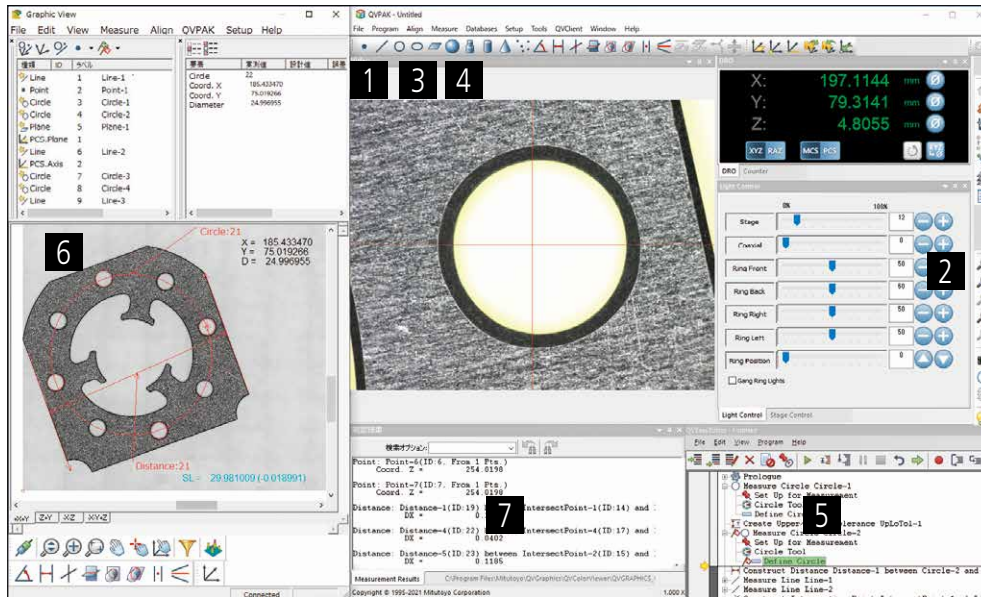

## 1 Large screen with high-definition color image for less eye fatigue

### High-definition color camera

Measurement and observation is performed using high-quality and high-definition images, which prevents operator fatigue even over long periods of observation.

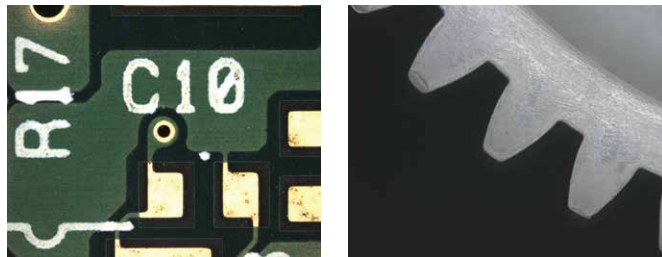

## 2 Edge sharpening means reliable measurement

### Matching lighting to the feature

Transmitted, co-axial and 4-quadrant ring lighting is provided so that workpiece illumination can be set independently from the front, rear, right and left directions. This enables more reliable measurement by enhancing the sharpness of the edge of the feature to be measured.

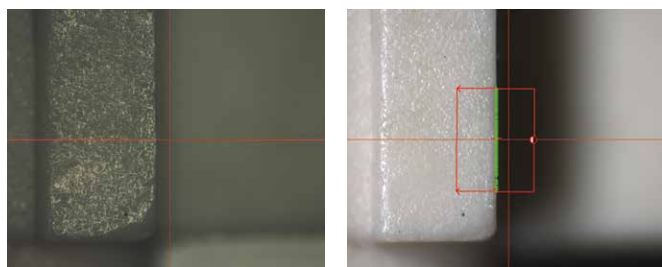

A feature viewed by co-axial light only.

The same feature viewed with the measured edge sharpened by ring lighting from the left.

## 3 Widefield view enables the measuring point to be found easily

### Zoom lens

The newly designed zoom lens enables the area of interest to be quickly found, from where the measuring point is easily and quickly identified by zooming to higher magnification.

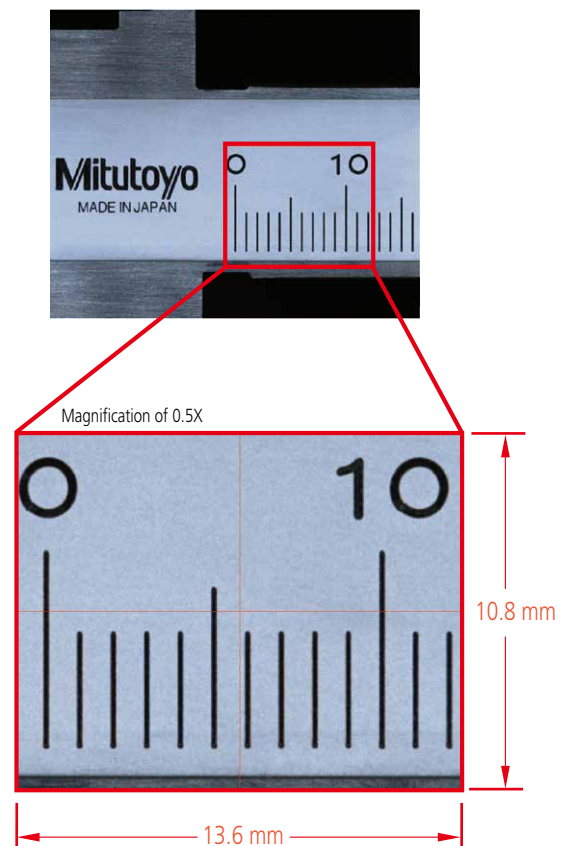

## 4 Easy-to-operate for beginners

### One-click tool

After selecting the element to be measured (circle, line, etc.), just one click on an edge enables high-accuracy measurement regardless of the proficiency level of the operator. The outlier removal function automatically excludes bad data caused by burrs and dust.

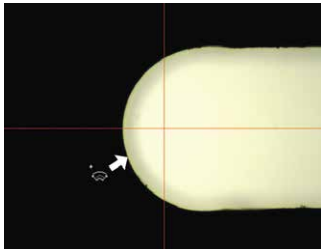

Move the mouse to the edge and click once.

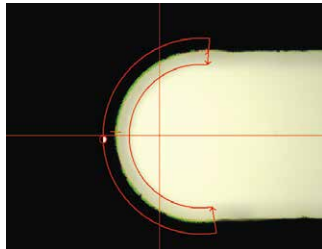

Executes high-accuracy multi-point measurement and removes the outlier

## 5 Expertise not required Creating and editing an automatic measurement program

### QVEasyEditor

A teaching method is adopted in which programs are automatically recorded while measurement is performed. The insertion, revision, addition, and deletion of the part program can be performed easily using the tree-structure display. Also, execution of only a certain portion of the program after editing can be performed for the purpose of confirmation. Power-user-oriented QVBasicEditor is also available as before.

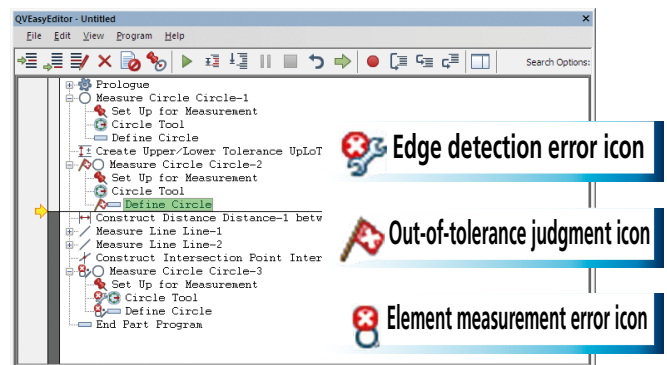

Easy-to-read tree-structure view

## 6 Graphical element analysis

### QVGraphics

A simple operation, by just clicking an element shown in the graphic window enables coordinate creation/change, combination arithmetic operations, and geometric deviation illustration of roundness, flatness, and other features. A key example of this is the automatic creation of a measurement program just by dragging a pitch measurement element.

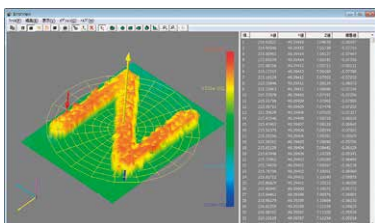
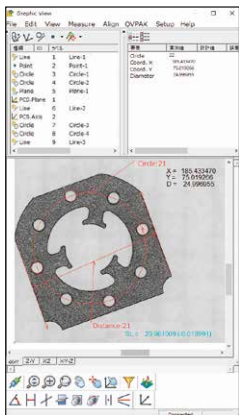

Geometric deviation of a plane surface

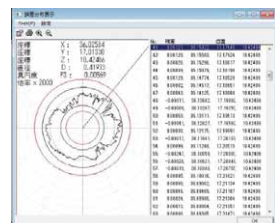

## 7 Direct output of measurement report

### MiCAT Reporter

Equipped as standard in order to create reports from the QVPAK measurement results, the software can output data into PDF form directly. This allows you to create reports that require a certain level of reliability such as medical component reports.

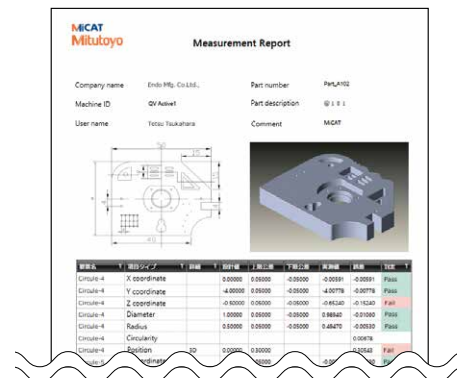

## Optional accessories

### FORMTRACEPAK-AP

This is contour analysis software that can perform sophisticated analyses, such as tolerancing and form analysis on the basis of the point cloud data obtained with **QVPAK** auto trace tools.

#### Contour tolerancing function

- Creating design data  
CAD data conversion, master work conversion, function assignment, text file conversion, creating spherical surface design data
- Verification of design data  
Verification of normal line direction, axial direction, and best fit
- Result display  
Result list, error diagram, error development diagram, error coordinate values, analysis results

#### Form analysis

- Analysis items: Point measurement, line measurement, circle measurement, distance measurement, intersection point measurement, angle measurement, origin point setting, axis rotation
- Arithmetic operation items: Maximum value, minimum value, mean value, standard deviation, area

#### Report creation function

- Measurement results, error diagram, error development diagram

#### Other functions

- Record/execution of analysis procedure
- External output function  
CSV format output, text output, DXF/IGES format output
- Fairing
- Quadratic curve approximating function
- Pseudo roughness analysis function

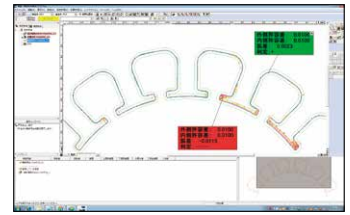

Tolerancing example

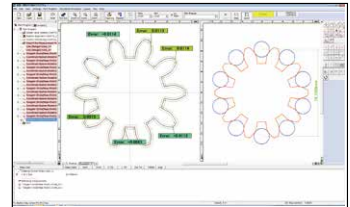

Example of gear contour matching and over-pin measurement

### QV3DCAD

**QV3DCAD** creates a QVPAK part program from a 3D CAD model.

The current version supports two modes: the online mode that allows you to teach while monitoring the actual workpiece by synchronizing the software with the QV system, and the offline mode that allows you to create a part program on a PC not connected to the main unit.

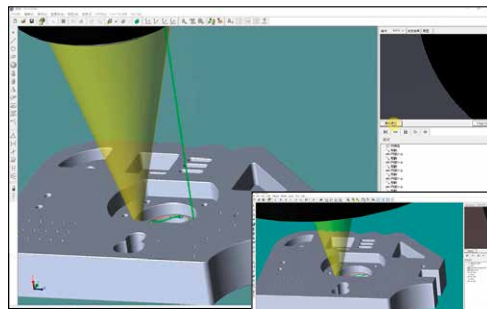

Offline teaching mode

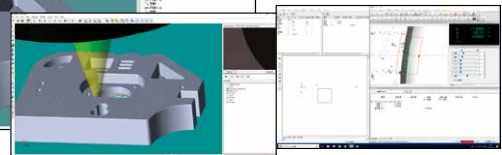

Online teaching mode

### QVEio

**QVEio** is client application software for external control.

It provides three functions, **QVEio-PLC**, **QVEio-PC**, and **QVEio-Signal**.

Note: These features use QVBasic language commands.

**QVEio-PLC** is software that can inform a user of the state of an external execution command or an execution command via the RS-232C communication with the PLC. Automation systems such as those that connect with automatic transport robots can be constructed without difficulty.

**QVEio-PC** can efficiently control QV Active using a GUI that is specific to an external PC via RS-232C communication. It also provides the measurement result output and error state output. **QVEio-Signal** informs the PLC of the operating status of **QV Active**. This function is best suited for displaying the operating status of QV Active on the signal tower or the like.

### MeasurLink Real-Time Professional

This is a process management program that can perform statistical processing control (SPC) based on measurement results.

Display of the control chart in real time enables early detection of machining abnormality, which is effective in preventing the generation of defective products.

QVPartManager is separately required to statistically process with **MeasurLink** the results of continuous measurement of multiple workpieces arranged on the measuring stage.

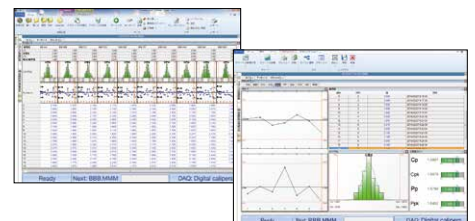



## Specifications

Model No.	QUICK VISION Active 202		QUICK VISION Active 404		
	QV-L202Z1L-D	QVT1-L202Z1L-D	QV-L404Z1L-D	QVT1-L404Z1L-D	
Type	Standard model	Touch-probe equipped model	Standard model	Touch-probe equipped model	
Measuring range (X×Y×Z)	250×200×150 mm (250×200×118 mm: when 1X objective lens is used)		400×400×200 mm (400×400×168 mm: when 1X objective lens is used)		
Resolution	0.1 μm				
Scale type	Linear encoder				
Observation unit	Zoom unit (8 positions)				
Imaging device	Color CMOS camera				
Illumination Unit	Co-axial Light	White LED			
	Transmitted Light	White LED			
	PRL	4-quadrant fixed white LED			
Accuracy*1	E <sub>1x</sub> , E <sub>1y</sub>	(2 + 3L/1000) μm			
	E <sub>1z</sub>	(3 + 5L/1000) μm			
	E <sub>2</sub>	(2.5 + 4L/1000) μm			
	Accuracy guaranteed with optics specified	Objective: 1.5X, Optical magnification: 5.25X			
Touch-trigger probe measuring accuracy*1	E <sub>1x</sub> , E <sub>1y</sub> , E <sub>1z</sub>	—	(2.4 + 3L/1000) μm	—	(2.4 + 3L/1000) μm
Accuracy guaranteed temperature range	20±1 °C	18 to 23 °C	20±1 °C	18 to 23 °C	
Size of stage glass	311×269 mm		466×480 mm		
Maximum stage loading*2	10 kg		20 kg		
Dimensions	570×767×1468 mm		776×1303×1529 mm		
Mass (including machine stand)	155 kg		324 kg		
Temperature compensation function	—	Manual	—	Manual	

\*1 Inspected to a Mitutoyo standard. L=length between two arbitrary points (mm)

\*2 Does not apply for unbalanced or concentrated loads.

### Option

#### Calibration chart

This chart is used to correct the pixel size of image elements, correct the accuracy of automatic focusing at each magnification, and correct optical axis offset.

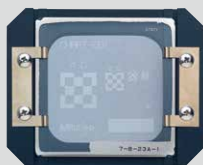

QUICK VISION Active 202



QUICK VISION Active 404

External dimensions and measurement stage dimensions

QUICK VISION Active 202

Unit: mm

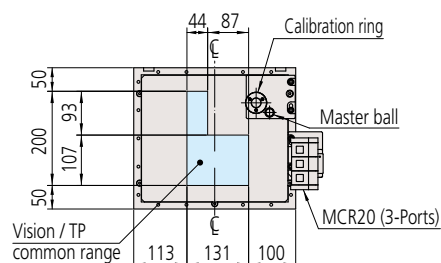
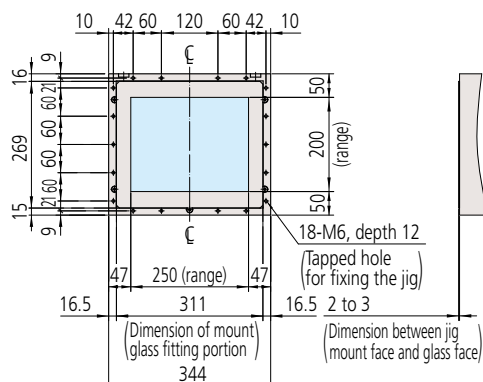
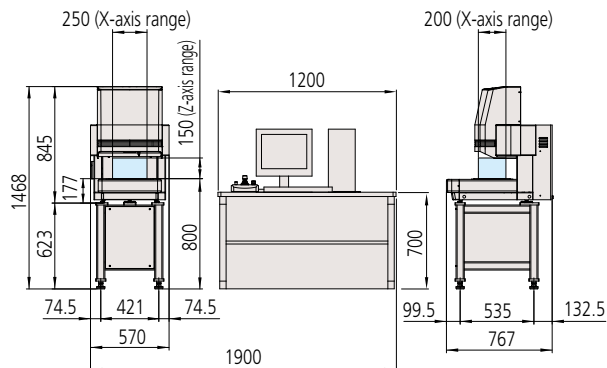

QUICK VISION Active 404

Unit: mm

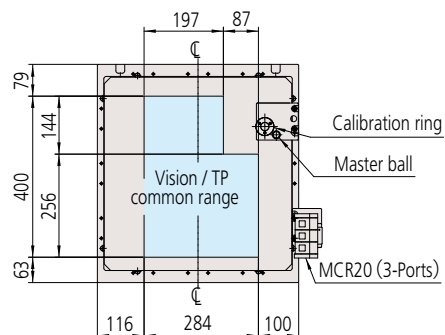
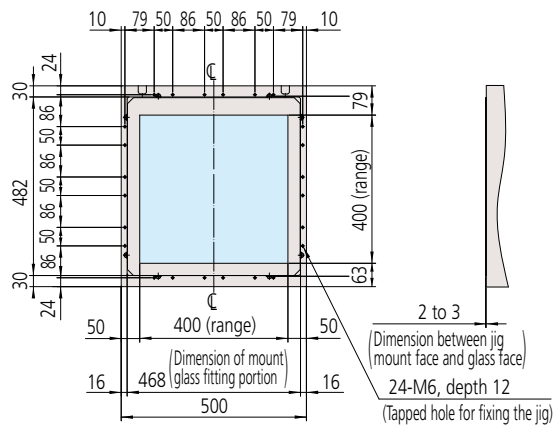
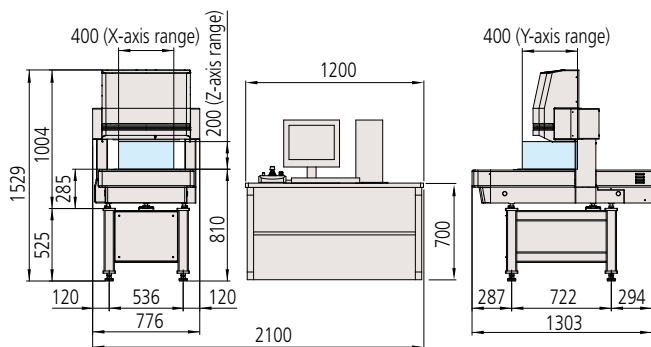

## Excellent reliability

### Adopting reference instruments traceable to the national standard

To build customer trust, we adhere to traceability to the national standard.

- Mitutoyo's calibration artifacts and instruments that are used to establish machine accuracy specifications are maintained in a continuous chain of traceability to national dimensional standards. This is our customers' assurance of reliable measurement.
- Our calibration service provider is JCSS certified by IAJapan, which is a certifying body internationally accredited by ILAC in accordance with MRA (Mutual Recognition Arrangement). It has been qualified for measurement techniques equivalent to those of international calibration organizations.

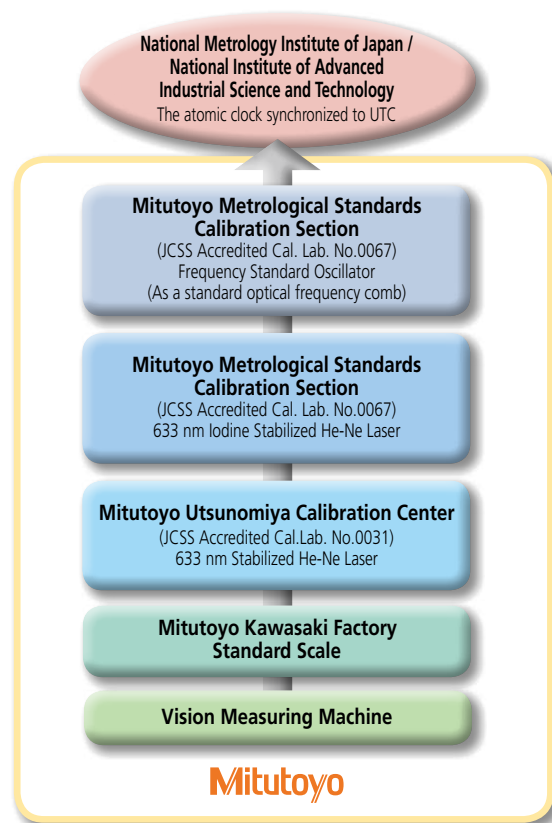

## Reliable support system

### World's top level of global network

Mitutoyo has expanded its market all over the world since the establishment of the first overseas sales company, MTI Corporation (current Mitutoyo America Corporation) in the USA in 1963. At present, we have R&D, manufacturing, sales, and technical service bases in 29 countries with an agency network connecting over 80 countries.



Company Headquarters in Kawasaki, Japan

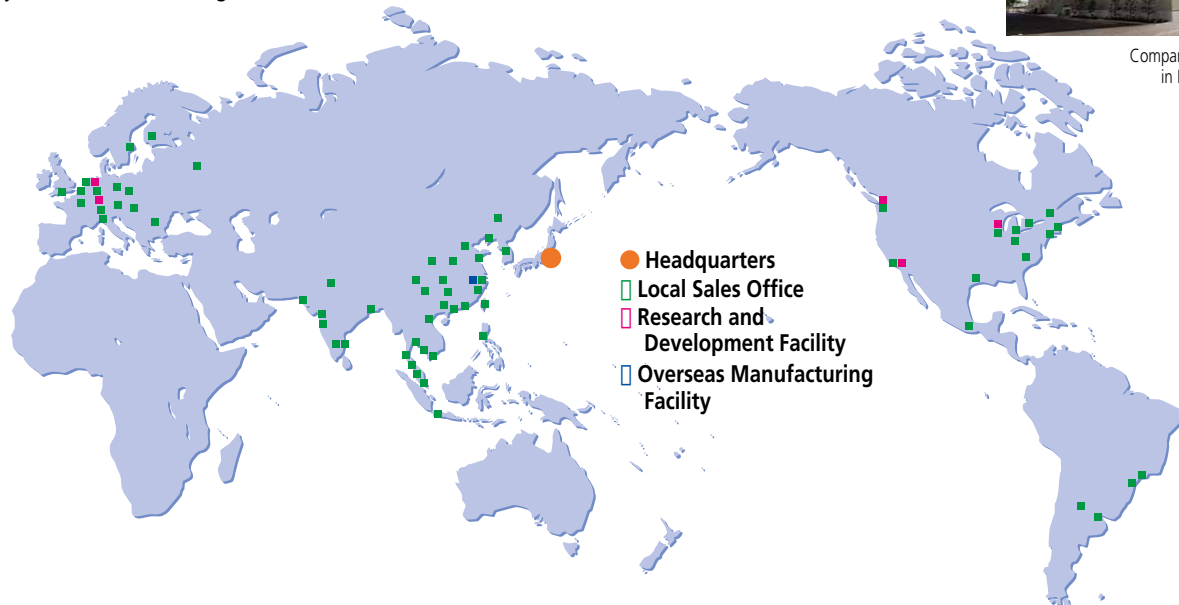

Mitutoyo Europe GmbH



Mitutoyo (UK) Ltd.



Mitutoyo France S.A.R.L.



Mitutoyo America Corporation Head Office



Mitutoyo Italiana S.R.L.



Mitutoyo Asia Pacific Pte. Ltd. Regional Headquarters



MITUTOYO SUL AMERICANA Ltda.

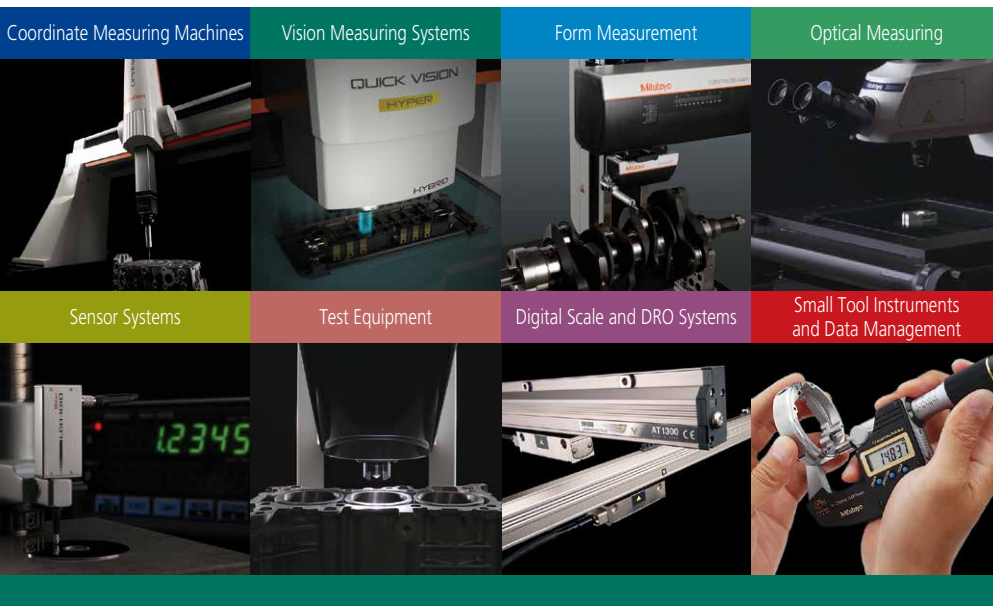

**Mitutoyo supports you from start to finish.**

Mitutoyo is not only a manufacturer of top-quality measuring products but one that also offers qualified support for the lifetime of the equipment backed up by comprehensive services, ensuring your staff can make the very best use of the investment.

Apart from the basics of calibration and repair, Mitutoyo offers product and metrology training, as well as IT support for the sophisticated software used in modern measuring technology. We can also design, build, test, and deliver bespoke measuring solutions and even, if deemed cost-effective, take your critical measurement challenges in-house on a sub-contract basis

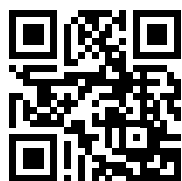

**Find additional product literature and our complete catalog here.**

[www.mitutoyo.eu](http://www.mitutoyo.eu)

**Note:** MITUTOYO is either registered trademarks or trademarks of Mitutoyo Corp. in Japan and/or other countries/regions. Other product, company and brand names mentioned herein are for identification purposes only and may be the trademarks of their respective holders. Product illustrations are without obligation. Product descriptions, in particular any and all technical specifications, are only binding when explicitly agreed upon.

**Mitutoyo**

**Mitutoyo Europe GmbH**

Borsigstraße 8-10  
41469 Neuss

Tel. +49 (0) 2137-102-0

info@mitutoyo.eu  
www.mitutoyo.eu